

MT1440 / MT1840

TELESCOPIC HANDLERS



MT 1440 / MT 1840

2 models, 8 versions to choose from



MT 1440

14 m / 4 T



MT 1840

18 m / 4 T





MANITOU: AT YOUR SIDE ON ANY CONSTRUCTION SITE

When it comes to all-terrain handling, MANITOU has been at your side on all your construction sites for over 50 years!

These MT 1440/1840 telescopic handlers are **high performers**: they have an excellent working envelope and a lifting **capacity of up to 4 tonnes**.

These handlers offer you unique **adaptability**:

- **Commonality of design** making them easy to use and maintain
- **Wide stabiliser legs** for unparalleled lateral and frontal **stability**
- **A choice of transmission**: torque converter or hydrostatic
- **Efficiency**: change the attachment within seconds

These trucks are true allies in your quest for **productivity** and **simplicity**.

High **performing** MANITOU telescopic handlers allow you to carry out all your construction work **safely** and **efficiently**.



SIMPLICITY

■ ■ Simplified **USAGE** and **MAINTENANCE**

COMMONALITY whatever the model

Spacious and comfortable cabin



Ergonomic dashboard

- All the information you need: direction of travel, wheel alignment, boom angle, fuel level, hour meter etc.
- **Stability indicator** cutting off aggravating movements. You choose between a **handling or suspended load mode** in order to optimise your handling.

JSM® : everything in the palm of your hand

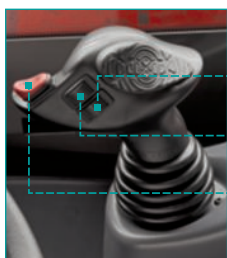

- Attachment function control
- Extension/retraction control for the boom
- Forward/backward/neutral movement selector switch

Work **SIMPLY** and **SAFELY**

- Baskets capacity **up to 1000 kg** with **automatic locking of the rear axle**. (MT 14/18 'A' Models only).
- **Automatic Parking Brake** next to the hill start assistance button.
- **EASY CONNECT SYSTEM** allowing the depressurisation of the hydraulic attachment line without turning off the engine.
- Adjustable **continuous flow of hydraulics** to the auxiliary services.
- **Tilt lock** out facility for enhanced safety.
- **Digicode** as standard for security and immobilisation.
- **Radio control** (optional).





IDENTICAL MAINTENANCE whatever the model

- Engine, transmission, hydraulics, cab and chassis. All benefit from the same design.
- **Double opening of engine compartment** without the need for disassembly: save time during maintenance.

PANORAMIC CABIN: 360° VISIBILITY



SAFE AND QUICK ACCESS

via a large door and non-slip steps

Machine MAINTENANCE and DIAGNOSIS

Periodic maintenance and diagnosis display on the **multifunction screen** on the dashboard.

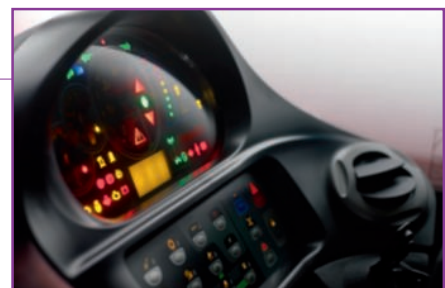

PRODUCTIVITY

PERFORMANCE and ADAPTABILITY

Power 102 HP

New generation engine
STAGE 3B with particle
filter.



Transmission adapted to your needs

hydrostatic or **torque convertor**
to fit your requirements (inching
optional).

Permanent 4 wheel drive

with **powerful braking** on both
axles.



Good ground clearance
up to **42 cm**

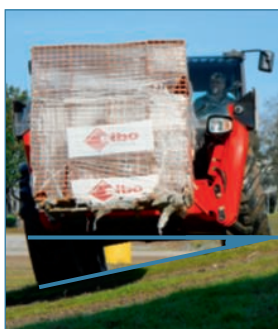

2 lifting heights

14.18 m

1 nominal capacity

4 T

Chassis levelling +/- **9°**



Good lateral and frontal stability:

The excellent stability allows loads to be easily and safely placed.

Good ground clearance on stabiliser legs:

Whatever the condition of the ground, the levelling of the machine on stabiliser legs is simple.



Turning circle

< 4 m



High tearout force

Three steering modes



4 wheel drive for short turns in restricted areas



Front wheel drive for road use



Crab steer for sideways approaches

Your MANITOU truck is a real **tool box...**



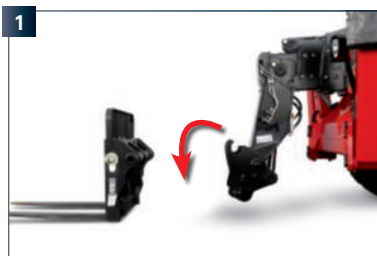

Thanks to the MANITOU **attachment system**, you can **easily equip your handler with numerous attachments within seconds**: forks, buckets, mixer buckets, baskets etc.



...for a **multitude of applications**

The **adaptable** MANITOU machines **meet all your working needs and optimise work time and productivity**:

- load placement
- distribution of materials on confined construction sites
- loading loose material
- positioning suspended loads
- lifting people

LOAD PLACEMENT				
Forks	Hook crane jib	Crane jib	Extendable roof crane jib	Winch
				

LOADING		
Construction bucket	4 in 1 Bucket (MT 1440 only)	Handling bucket
		

ACCESS	
Fixed basket 365 kg	Extendable basket 1000 kg
	

OTHERS	
Mixer bucket	Skip
	







Tailor-made finance to make the best use of your funds

You can plan the purchase of your forklift with peace of mind by using MANITOU* financing opportunities.

You will have simple solutions adapted to your needs and seasonal requirements. If you want to make a rapid investment, consider asking us for a personalised proposal to take your situation into account.

* MANITOU Finance solutions are available in certain countries.

MANITOU maintenance contract

2 levels of maintenance adapted to your needs. You are sure of:

- equipment always in good working condition
- a reduction of repair costs as a result of regular servicing
- authentic standardised services

- Labour
- Attendance costs



- Labour
- Attendance costs
- Parts and lubricants



MANIPLUS extension of guarantee

With MANIPLUS you can take out an extension of guarantee of 12 or 24 months.

EASY MANAGER

A simple and flexible system for fleet management (with or without geolocation) to provide optimum service from your machines. EASY MANAGER gives you:

- real-time materials management
- simple and easy way of managing your machinery activity and maintenance.
- maximise your asset and safeguard your equipment



MANITOU spare parts

Utilising genuine MANITOU spare parts is sure to prolong the best performance capability of your machine. Your MANITOU dealer has access to a stock of 70,000 part numbers, available in 24 hours in Europe (48 hours outside Europe).

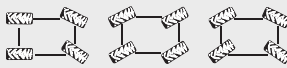

MT1440

	MT 1440	MT 1440 A	MT 1440 H	MT 1440 HA
Lifting				
Max. capacity			4000 kg	
Max. lifting height			13.53 m	
Max. outreach			9.46 m	
Break-out force with bucket			7400 daN	
Unladen time				
Lifting	15.5 secs	15.7 secs	15.5 secs	15.7 secs
Lowering	11.6 secs	13.3 secs	11.6 secs	13.3 secs
Extension	16.5 secs	19.2 secs	16.5 secs	19.2 secs
Retraction	11.9 secs	14.8 secs	11.9 secs	14.8 secs
Crowd			4 secs	
Dump			4 secs	
Tyres			400/80-24	
Braking				
Service brake		oil immersed multi-disc braking on front/rear axles		
Parking brake		automatic negative handbrake		
Engine		PERKINS - STAGE 3B		
Type		854E-E34TA		
Cubic capacity		3400 cm ³		
Power		102 HP/75 kW		
Max. torque		420 Nm - 1400 rpm		
Injection		direct		
Cooling		water		
Laden drawbar pull	10700 daN			8000 daN
Transmission	torque converter 4 wheel drive			hydrostatic 4 wheel drive
Reversing shift		electrohydraulic control		
Number of gears (forward/reverse)	4/4			3/3
Max. travel speed (may vary according to applicable regulations)		25 kph or 35 kph		
Steering mode		4 wheel steer - 3 steering modes		
				
Controls		JSM® Joystick multi - function load limiter cut off system - EN15000 norm		
Hydraulics				
Pump		gear type with flow splitter - 170 l/min - 270 bar		
Capacities				
Hydraulic oil		135 l		
Fuel		140 l		
Unladen weight (with forks)	10900 kg	11600 kg	10900 kg	11600 kg
Dimensions				
1. Front wheel centre to carriage		1.90 m		
2. Wheelbase		3.07 m		
3. Rear wheel centre to rear face		1.16 m		
4. Overall length to carriage		6.13 m		
5. Ground clearance		0.37 m		
6. Overall width of cab		0.89 m		
7. Inside tyre width		1.96 m		
8. Overall width		2.37 m		
9. Overall width (stabilizers lowered)		3.79 m		
10. Overall height		2.45 m		
Standard forks (length x width x thickness)		1200 x 125 x 50 mm		
Turning radius (over tyres)		3.97 m		
Frame levelling		+/- 9°		
Carriage rotation (crowd/dump)		12°/114°		
Noise and vibration				
Noise at driving position (LpA)		82 dB		
Environmental noise (LwA)		106 dB		
Vibration to whole hand/arm		<2.5 m/s ²		

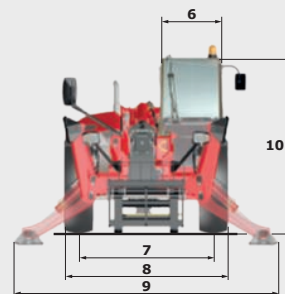
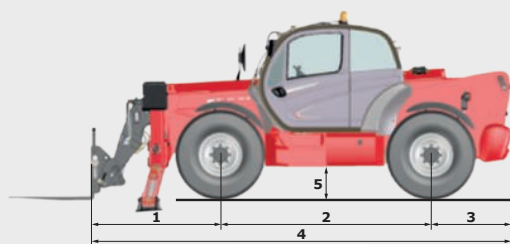

Rough terrain load chart standard EN1459 B

Machine on tyres with forks

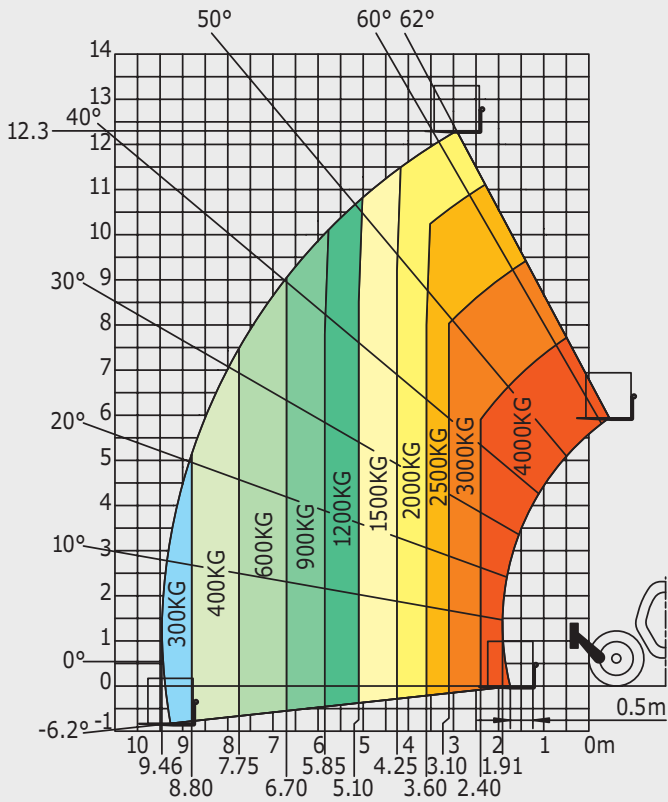

Machine on stabilizers with forks

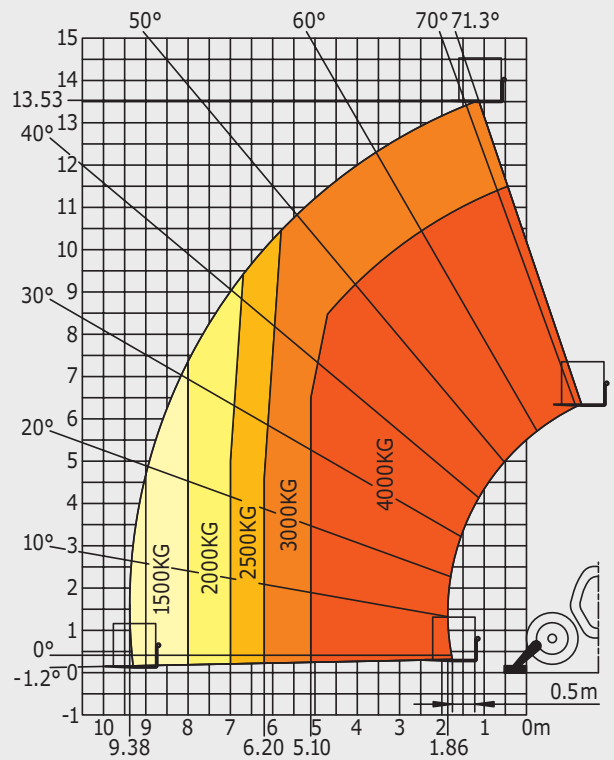

Machine on stabilizers with platform (MT 1440 A and MT 1440 HA versions)

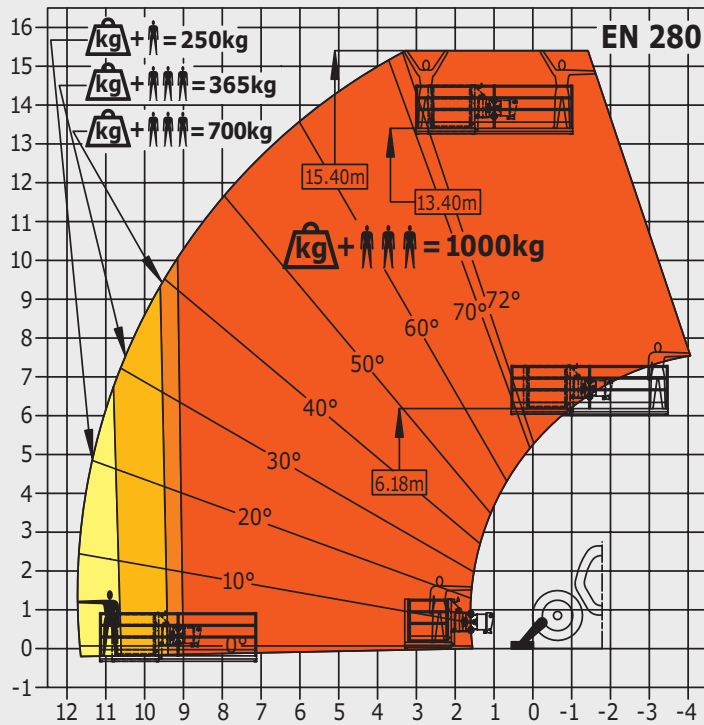

This brochure describes versions and configuration options for Manitou products which may be fitted with different equipment. The equipment described in this brochure may be standard, optional or not available depending on version. Manitou reserves the right to change the specifications shown and described at any time and without prior warning. The manufacturer is not liable for the specifications given. For more information, contact your Manitou dealer. Non-contractual document. Product descriptions may differ from actual products. List of specifications is not comprehensive. The logos and visual identity of the company are the property of Manitou and may not be used without authorisation. All rights reserved. The photos and diagrams contained in this brochure are provided for information only.

MANITOU BF SA - Limited company with board of directors - Share capital: 39,547,824 euros - 857 802 508 RCS Nantes

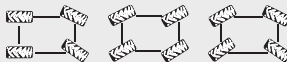

MT1840

	MT 1840	MT 1840 A	MT 1840 H	MT 1840 HA
Lifting				
Max. capacity			4000 kg	
Max. lifting height			17.55 m	
Max. outreach			13.08 m	
Break-out force with bucket			7900 daN	
Unladen time				
Lifting	17.3 secs	18.0 secs	17.3 secs	18.0 secs
Lowering	12.7 secs	14.4 secs	12.7 secs	14.4 secs
Extension	16.1 secs	17.9 secs	16.1 secs	17.9 secs
Retraction	15.6 secs	16.5 secs	15.6 secs	16.5 secs
Crowd			5 secs	
Dump			4 secs	
Tyres			440/80-24	
Braking				
Service brake		oil immersed multi-disc braking on front/rear axles		
Parking brake		automatic negative handbrake		
Engine				
Type		PERKINS - STAGE 3B		
Cubic capacity		854E-E34TA		
Power		3400 cm ³		
Max. torque		102 HP/75 kW		
Injection		420 Nm - 1400 rpm		
Cooling		direct water		
Laden drawbar pull	10300 daN			7300 daN
Transmission				
Reversing shift		torque converter		
Number of gears (forward/reverse)	4/4			3/3
Max. travel speed (may vary according to applicable regulations)		25 kph or 35 kph		
Steering mode		4 wheel steer - 3 steering modes		
				
Controls				
		JSM® Joystick multi - function		
		load limiter cut off system - EN15000 Norm		
Hydraulics				
Pump		gear type with flow splitter - 170 l/min - 270 bar		
Capacities				
Hydraulic oil		135 l		
Fuel		140 l		
Unladen weight (with forks)	11700 kg	12400 kg	11300 kg	12000 kg
Dimensions				
1. Front wheel centre to carriage		2.04 m		
2. Wheelbase		3.07 m		
3. Rear wheel centre to rear face		1.16 m		
4. Overall length to carriage		6.27 m		
5. Ground clearance		0.42 m		
6. Overall width of cab		0.89 m		
7. Inside tyre width		1.96 m		
8. Overall width		2.42 m		
9. Overall width (stabilizers lowered)		3.79 m		
10. Overall height		2.50 m		
Standard forks (length x width x thickness)		1200 x 125 x 50 mm		
Turning radius (over tyres)		4.01 m		
Frame levelling		+/- 9°		
Carriage rotation (crowd/dump)		12°/114°		
Noise and vibration				
Noise at driving position (LpA)		82 dB		
Environmental noise (LwA)		106 dB		
Vibration to whole hand/arm		<2.5 m/s ²		

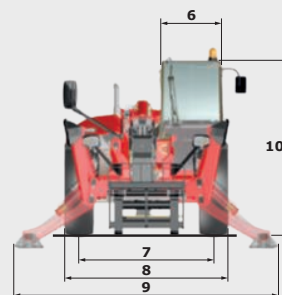
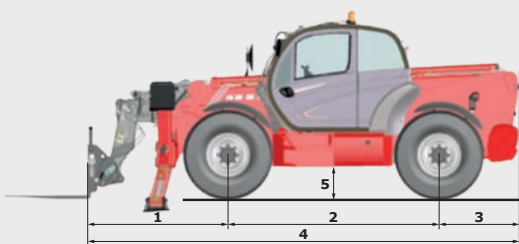

Rough terrain load chart standard EN1459 B

Machine on tyres with forks

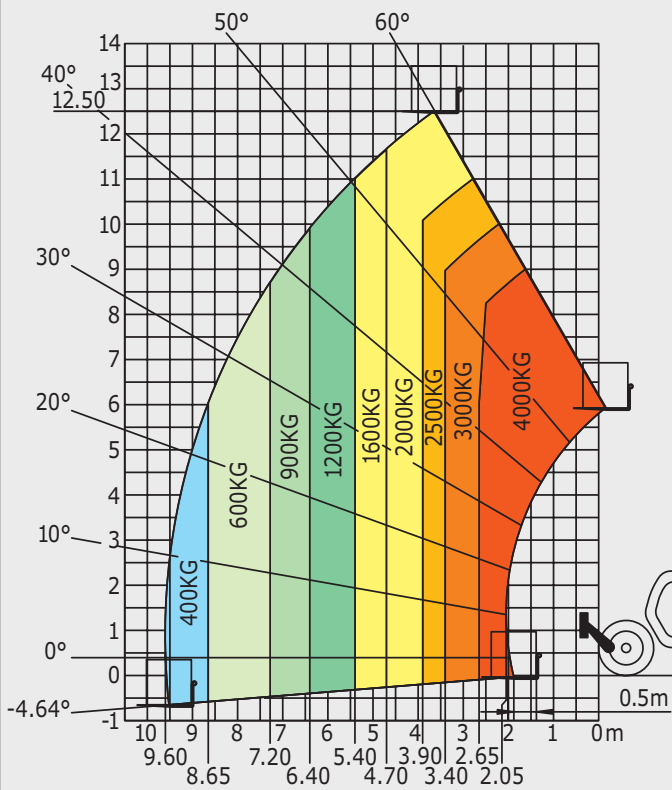

Machine on stabilizers with forks

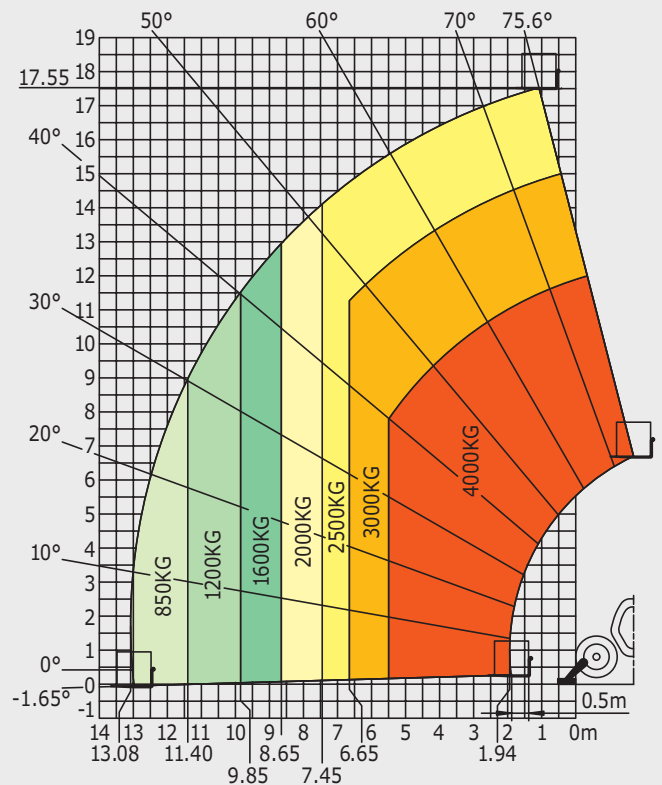

Machine on stabilizers with platform (MT 1840 A and MT 1840 HA versions)

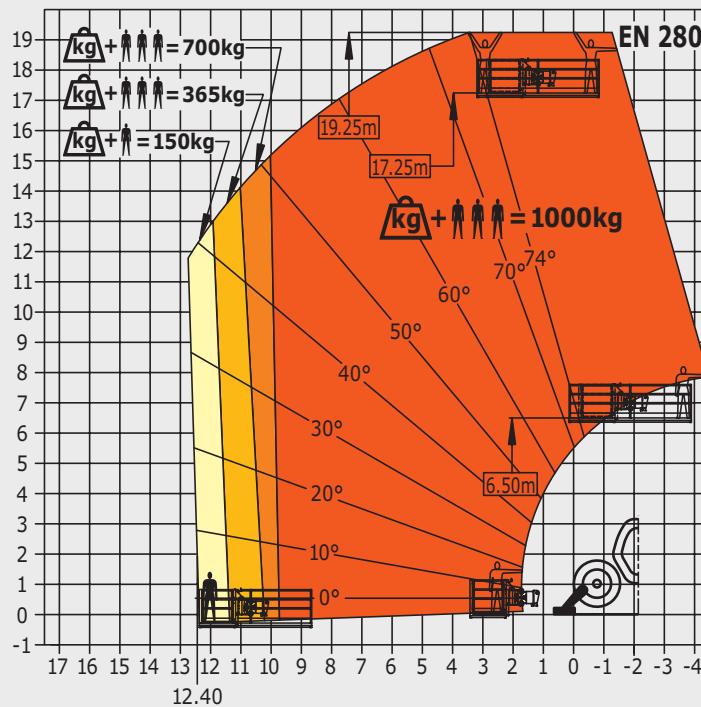

This brochure describes versions and configuration options for Manitou products which may be fitted with different equipment. The equipment described in this brochure may be standard, optional or not available depending on version. Manitou reserves the right to change the specifications shown and described at any time and without prior warning. The manufacturer is not liable for the specifications given. For more information, contact your Manitou dealer. Non-contractual document. Product descriptions may differ from actual products. List of specifications is not comprehensive. The logos and visual identity of the company are the property of Manitou and may not be used without authorisation. All rights reserved. The photos and diagrams contained in this brochure are provided for information only.

MANITOU BF SA - Limited company with board of directors - Share capital: 39,547,824 euros - 857 802 508 RCS Nantes



Your nearest **MANITOU** dealer:



Head office:
B.P. 249 - 430 rue de l'Aubinière - 44158 Ancenis Cedex - France
Tel: 00 33 (0)2 40 09 10 11 - Fax: 00 33 (0)2 40 09 10 97
www.manitou.com