

P 480

HIGH-LEVEL PRECISION

LIFETIME EXCELLENCE

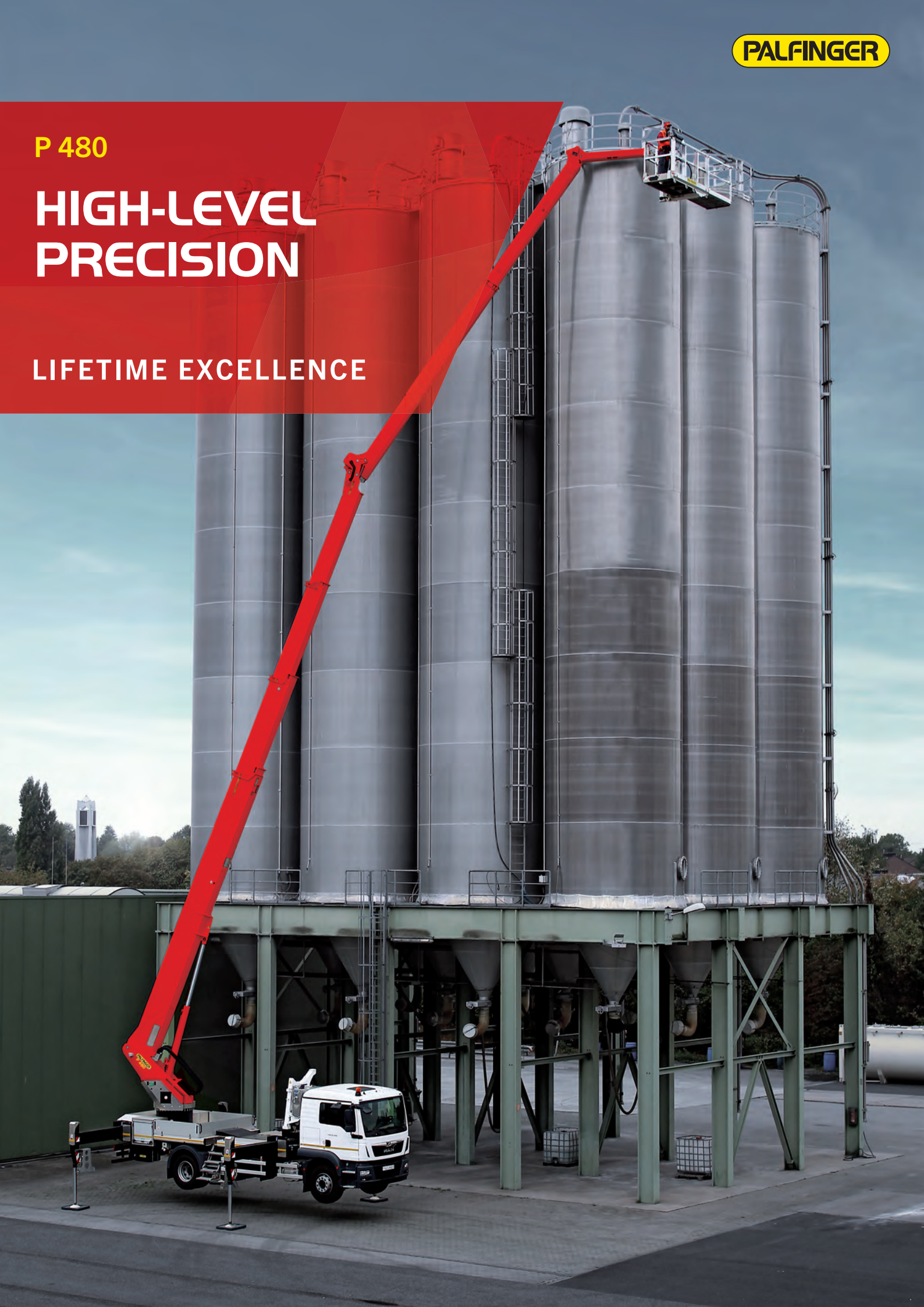

HIGHLIGHTS

- Greater flexibility thanks to 240° X-jib
- 2 x 200° rotation for perfect positioning of the workman basket
- Telescopic upper boom up to 17 m length
- 1000 mm stabilising stroke to compensate highly uneven terrain
- Telescopic basket with 600 kg basket load and integrated mount for Powerlift system
- Hanging basket enables users to get close to objects

STANDARDS













- Reverse camera
- Home function
- Automated positioning system
- Telescopic cage
- Safety plates
- 230 V CEE current supply with CEE socket in the workman cage
- Easy access through integrated stairs to platform
- Oil cooler to maintain the optimum operating temperature

OPTIONS

- Barrier-free Powerlift system
- Increasing the working range using counterweights
- Mobile radio remote controls for access platform and stabiliser operation
- Vertical parallel manoeuvrability of the workman basket for easy control along buildings
- Attachable cable winch under the workman basket with 460 kg lifting capacity



TECHNICAL SPECIFICATIONS

| | | | | | |
|---|-----------------------------|----------|---|-----------------------------|----------------------|
|  | Total weight * | 17600 kg |  | max. outreach | 31 m |
|  | Overall length | 9,92 m |  | Rotation angle of turntable | 540° |
|  | Width in transportposition | 2.51 m |  | Rotation angle of cage | 2 x 200° |
|  | Height in transportposition | 3.96 m |  | Rotation angle of cage boom | 240° |
|  | max. stabiliser width | 6.30 m |  | Size of cage | 3.88 x 1.05 x 1.10 m |
|  | max. working height | 48 m |  | max. cage load | 600 kg |
|  | max. cage bottom height | 46 m | | | |

* Depends on truck chassis

WORKING DIAGRAMS

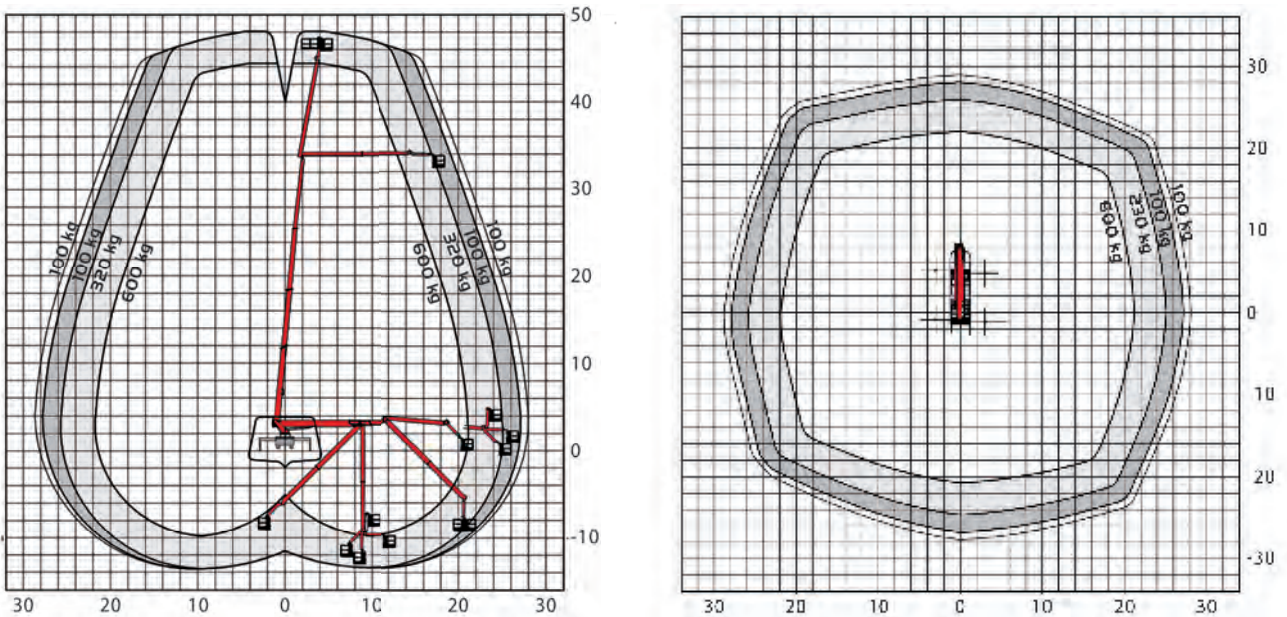

A possible 2% tolerance is contingent on structural components

DIMENSIONS

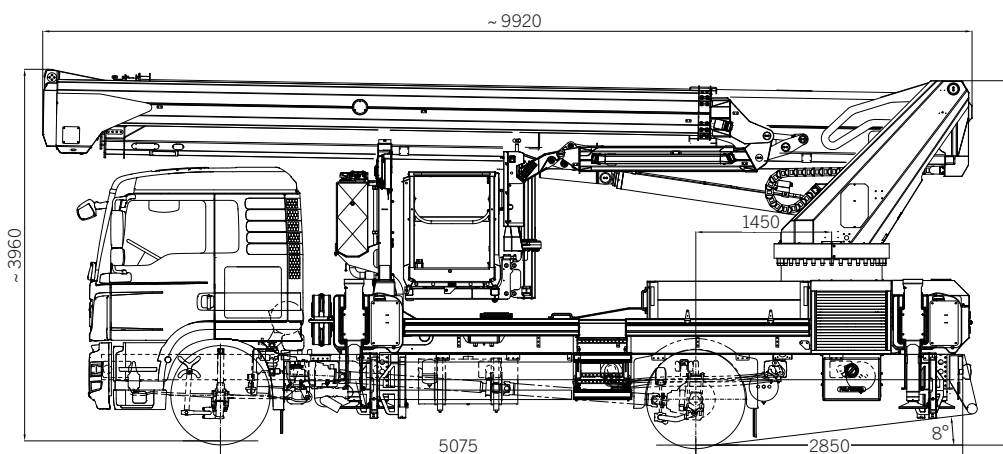

YOUR CONTACT

Palfinger Platforms GmbH

Düsseldorfer Str. 100
47809 Krefeld | Germany

KP-P480M2+EN

Units shown in the leaflet are partially optional equipped and do not always correspond to the standard version. Country-specific regulations must be observed. Dimensions may vary. Subject to technical changes, errors and translation mistakes.