



6.39



MAIN SECTORS



INDUSTRY



CONSTRUCTION



FEATURED PROJECTS

Maximum lifting height: 38.90 m
Maximum reach: 27.00 m
Electronically controlled hydrostatic transmission
Automatic levelling device
Scissors stabilizers

MACHINE MODEL	Rotary telescopic handler	RTH 6.39		
	Maximum lifting capacity	6.000 kg (centre of gravity 600 mm)		
	Maximum lifting height	38.90 m		
	Rotation	360° (continuous)		
ENGINE	Type	Volvo TAD 583 VE Stage V	Volvo TAD 572 VE Stage IV	Volvo TAD 552 VE Stage IIIA
	Rated Power	175 kW (238 hp) @ 2,300 rpm	160 kW (218 hp) @ 2,300 rpm	160 kW (218 hp) @ 2,200 rpm
	Maximum torque	975 Nm @ 1,380 rpm	910 Nm @ 1,410 rpm	910 Nm @ 1,450 rpm
	Displacement	5,13 l		
	Cylinders	4 in line		
	Engine configuration	Turbocharged direct injection diesel		
	Cooling System	Water – intercooler		
TRANSMISSION	Type	Hydrostatic		
	Model	Danfoss / Rexroth		
	Maximum pressure	480 bar		
	Displacement	Electronically controlled variable displacement pump Variable displacement motor		
	Gearbox	Dropbox, 2 speeds forward-reverse		
AXLES AND BRAKES	Type	Axles with planetary gearboxes		
	Rear axle	Oscillating and steering with hydraulic locking		
	Front axle	Oscillating and steering with levelling +/-8°		
	Service brake	Hydraulically operated wet multi-disk brakes on each axle		
	Parking brake	Hydraulic with negative action		
	Tyre sizes	445/65 R22,5		
PERFORMANCE	Max. travel speed	40 km/h		
	Drawbar pull	152 kN		
	Gradeability	65%		
	Turning circle (at forks)	6,970 mm		
WEIGHTS	Total unladen	24,000 kg		
	Front axle unladen (boom retracted and lowered)	12,000 kg		
	Rear axle unladen (boom retracted and lowered)	12,000 kg		
TANK AND SYSTEM CAPACITIES	Diesel fuel tank	270 l	270 l	270 l
	AdBlue	40 l	40 l	-
	Hydraulic fluid	220 l	220 l	220 l
	Engine oil	16 l	16 l	16 l
	Cooling liquid	40 l	40 l	40 l
HYDRAULIC CIRCUIT FOR MOVEMENTS	Max. working pressure	350 bar		
	Circuit type	Load sensing		
	Service pump	Danfoss / Rexroth – Variable displacement		
	Distributor for boom and turret movements	Danfoss – SIL 2 electro-proportional valve		
	Distributor for stabilisers	Bosch Rexroth – Electro-hydraulic actuators		
	Movements control	2 no. two-axis Danfoss joysticks with deadman safety device Managed via CAN bus		
STANDARDS MET	EN 1459-2: concerning standards for slewing variable-reach trucks EN 13000: concerning standards for hydraulic cranes EN 280: concerning standards for mobile elevating work platforms FOPS/ROPS EU 2016/1628: concerning engine emissions standards			

The data in this brochure are informative and subject to change without notice

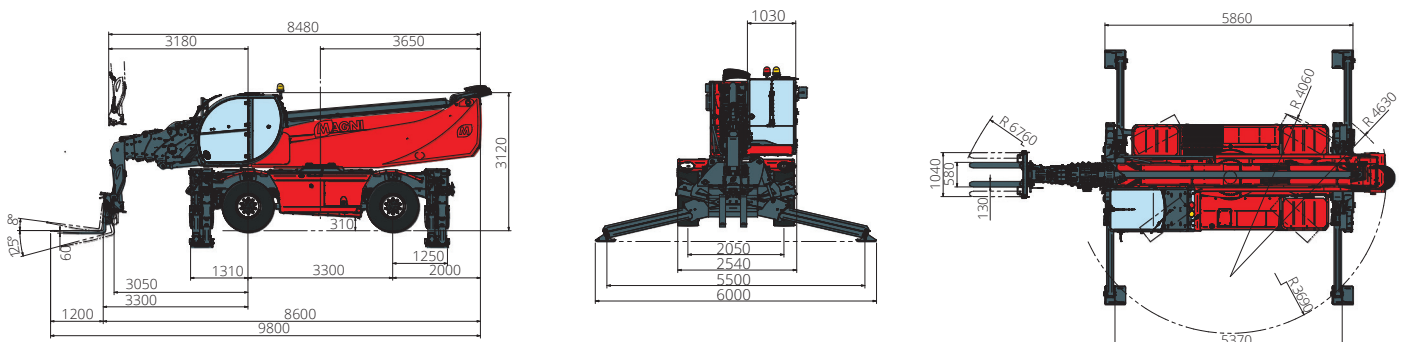

ON STABILISERS

360° LOAD CHART ON FULLY EXTENDED STABILISERS

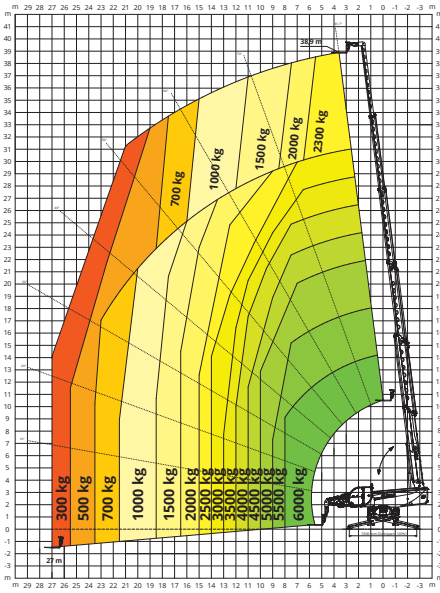

H 6

HOOK 6,000 kg

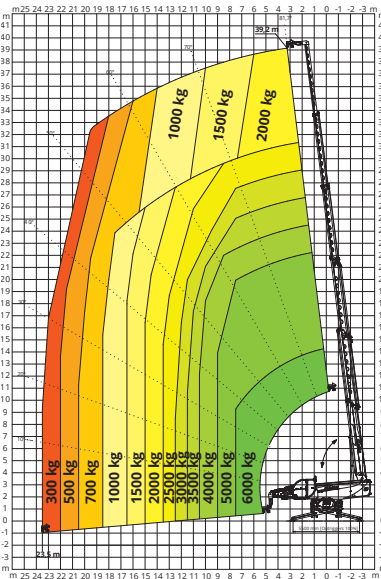

W 6

WINCH 6,000 kg

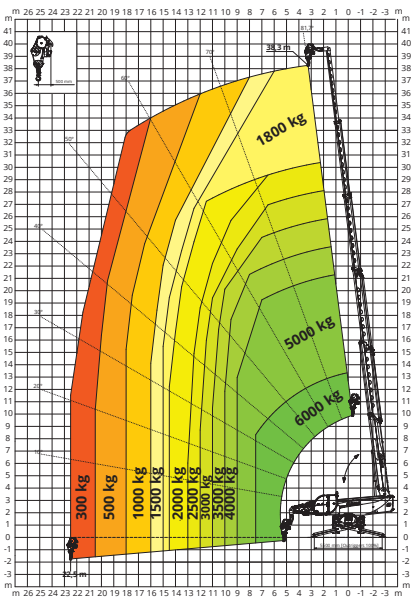

J 2000

FRONTAL LOAD CHART ON TYRES

ON TYRES

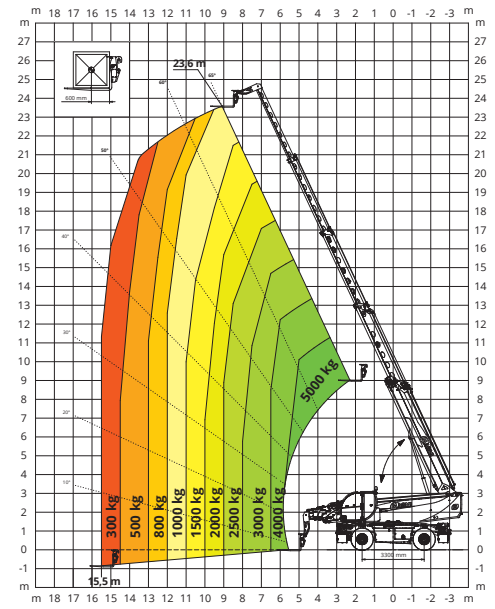

W 3,5

WINCH 3,500 kg

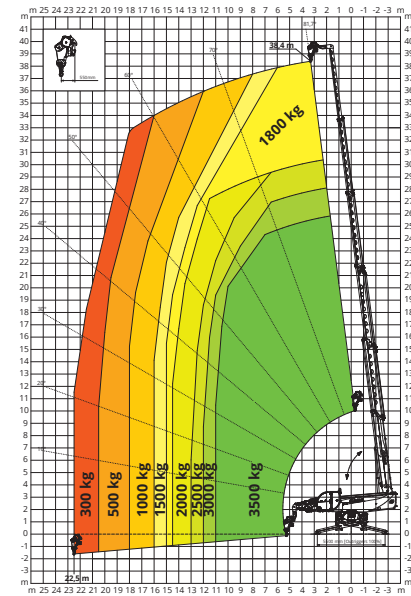

JIB WITH WINCH 2,000 kg

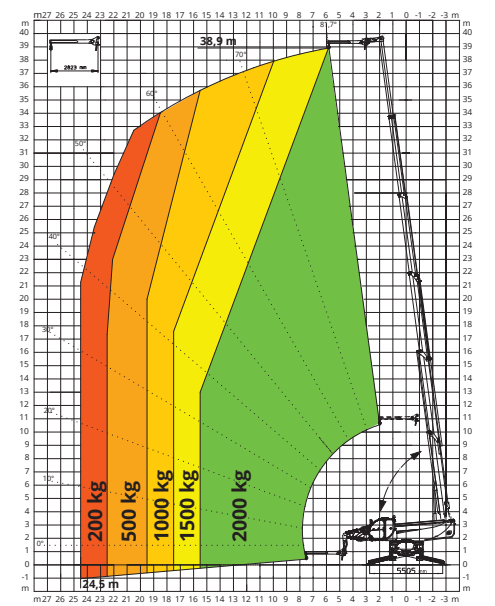

JW 1500

JIB WITH WINCH **1,500 kg**

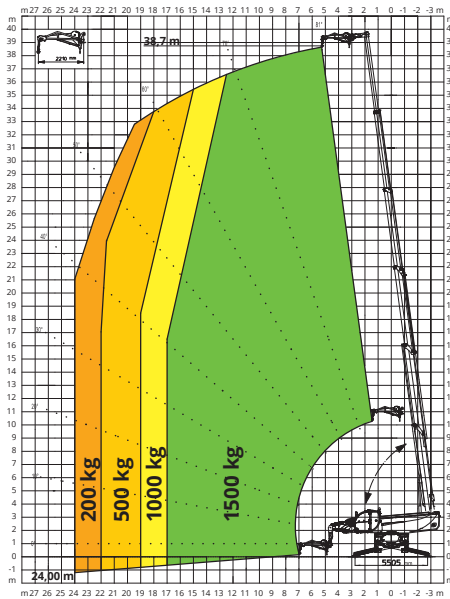

JW 2700

JIB WITH WINCH **2,700 kg**

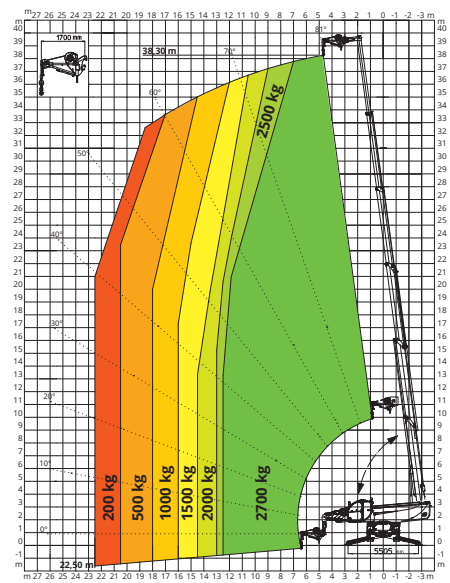

REP 2-4,5

ROTATING EXTENDABLE BASKET **500 kg**

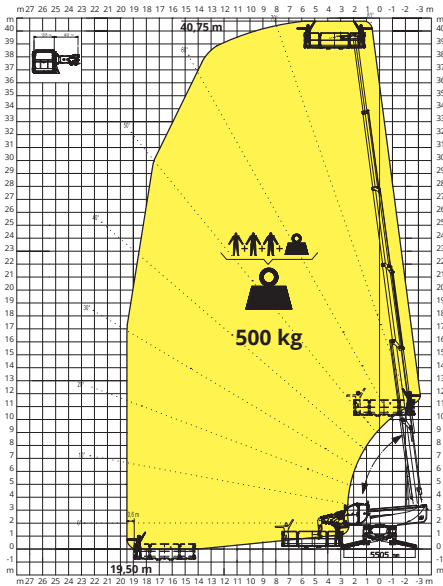

REP 10.2-4,7

ROTATING EXTENDABLE BASKET **1,000 kg**

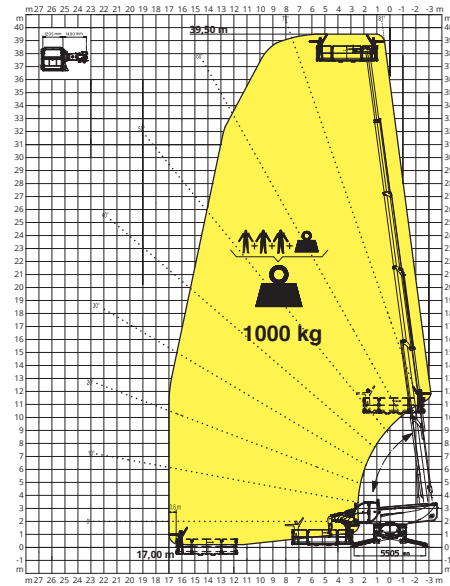

RP 2.2

ROTATING NON-EXTENDABLE BASKET **500 kg**

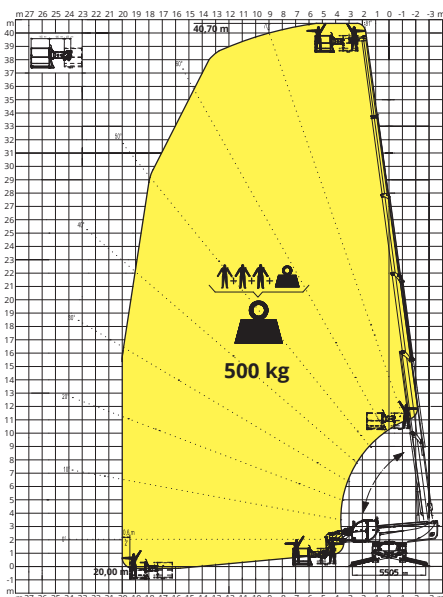

REP 8.2-4,7 W0,3

BASKET 6.5 m **500 kg**
WITH WINCH **300 kg**

